

都汇里

HC28 COSMO

HOME COLLECTION

都汇里，用“简约”的语言，重塑“奢华”的维度，与众多国际设计大师 Christophe Delcourt, Yonoh, 梁志天 Steve Leung 和 Roderick Vos 等，创造出高级有机，时尚有趣和优雅大气的现代家具系列，并以突破性的视角和国际化水准的精湛工艺，诠释高级奢华和新鲜多元的都会生活。

HC28 COSMO is a unique brand reinterpreting sleek luxury in modern and sophisticated style. Collaborating with renowned designers like Christophe Delcourt, Yonoh, Steve Leung and Roderick Vos, the brand has developed a versatile, trendy, fresh and elegant furniture collection. By its art of craft, HC28 COSMO represents a new cosmopolitan lifestyle in high quality and versatility.



PRODUCT INDEX

产品目录

沙发 SOFA	06-27
单人位 ARMCHAIR	28-31
茶几 COFFEE TABLE	32-35
边几 SIDE TABLE	36-38
条案 CONSOLE	39
电视柜 LIVING CABINET	40-42
餐桌 DINING TABLE	46-48
椅子 CHAIR	50-53
餐边柜 SIDEBOARD	54-55
床 & 床头柜 BED & BEDSIDE TABLE	58-63
书桌 & 书架 DESK & BOOK CASE	66-67
配饰 ACCESSORY	68
地毯 RUG	69



客厅

Living Room

SOFA

沙发



BOL 元阳
Christophe Delcourt



尺寸: 2250*835*632mm
2000*835*632mm
1020*835*632mm
编号: 31F004

产品描述: 沙发整体为布料或牛皮包制, 底框与底脚为实木开孔漆

PRODUCT DESCRIPTION: Upholstered with fabric or leather. Frame and feet in solid wood

BARRY 百瑞

Ximi Li 李希米

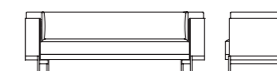

尺寸: 2300*850*770mm
编号: 31F019

产品描述: 沙发外侧为牛皮包制, 其他部分可选择面料或与外侧同色牛皮。底脚为黑灰氟碳漆金属

PRODUCT DESCRIPTION: Upholstered with fabric or leather, outside of the armrest and back in leather only. Metal feet in dark grey epoxy paint finish

NEST 巢

Studio Roderick Vos



尺寸: 1160*912*720mm
1960*912*720mm
2360*912*720mm
编号: 31F014

产品描述: 沙发整体为 Marshmallow 系列布料包制, 底脚为黑色烤漆金属

PRODUCT DESCRIPTION: Upholstered with fabric from the Marshmallow collection. Metal feet in black lacquer finish

CORE 相拥

Siyu Chen (CAFA) 央美陈思雨

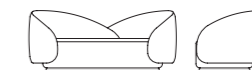

尺寸: 2000*866*735mm
1800*866*735mm
编号: 31F025

产品描述: 沙发整体为布料包制, 底脚为黑灰氟碳漆金属

PRODUCT DESCRIPTION: Upholstered with fabric. Metal feet in dark grey epoxy paint

BUFA 波波球

Yonoh



编号: 31F022

产品描述: 沙发整体为 Noah 系列布料包制, 底脚为黑丝光烤漆金属

PRODUCT DESCRIPTION: Upholstered with fabric from the Noah collection. Metal feet in black satin finish

沙发 SOFA

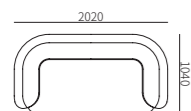

尺寸: 2020*1040*710mm
编码: 31F022-12

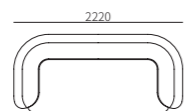

尺寸: 2220*1040*710mm
编码: 31F022-13

单扶 LEFT/RIGHT ONE-ARMED SOFA

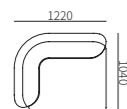

尺寸: 1220*1040*710mm
编码: 31F022-20

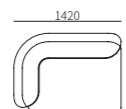

尺寸: 1420*1040*710mm
编码: 31F022-21

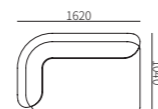

尺寸: 1620*1040*710mm
编码: 31F022-22

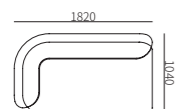

尺寸: 1820*1040*710mm
编码: 31F022-23

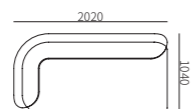

尺寸: 2020*1040*710mm
编码: 31F022-24

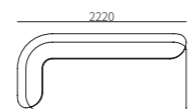

尺寸: 2220*1040*710mm
编码: 31F022-25

单背 SOFA WITHOUT ARM

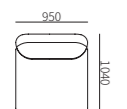

尺寸: 950*1040*710mm
编码: 31F022-30

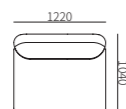

尺寸: 1220*1040*710mm
编码: 31F022-31

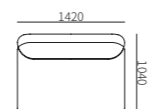

尺寸: 1420*1040*710mm
编码: 31F022-32

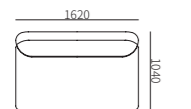

尺寸: 1620*1040*710mm
编码: 31F022-33

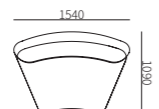

尺寸: 1540*1090*710mm
编码: 31F022-71

转角 LEFT/RIGHT CHAISE

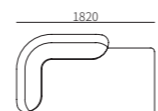

尺寸: 1820*1040*710mm
编码: 31F022-42

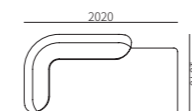

尺寸: 2020*1040*710mm
编码: 31F022-43

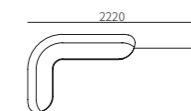

尺寸: 2220*1040*710mm
编码: 31F022-44

塌 OTTOMAN

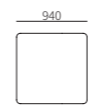

尺寸: 940*940*390mm
编码: 31F022-51

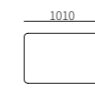

尺寸: 1010*670*390mm
编码: 31F022-52

角位 LEFT/RIGHT CORNER SEAT

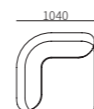

尺寸: 1040*1040*710mm
编码: 31F022-61

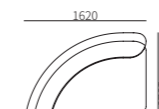

尺寸: 1620*1620*710mm
编码: 31F022-62

组合沙发 SECTIONAL SOFA

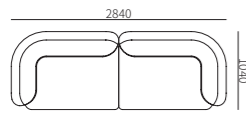

尺寸: 2840*1040*710mm

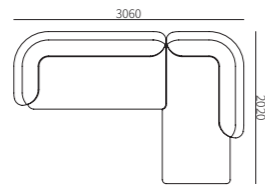

尺寸: 3060*2020*710mm

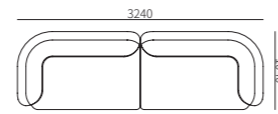

尺寸: 3240*1040*710mm

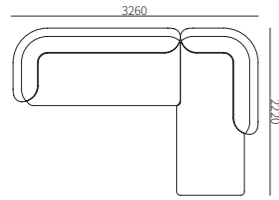

尺寸: 3260*2220*710mm

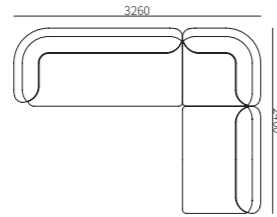

尺寸: 3260*2460*710mm

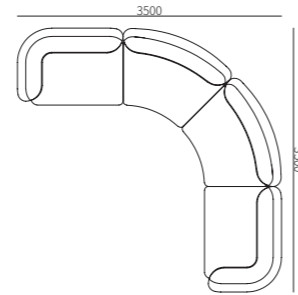

尺寸: 3500*3500*710mm

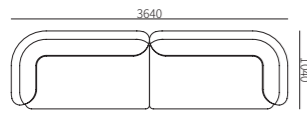

尺寸: 3260*2220*710mm

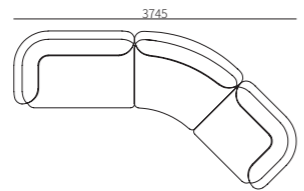

尺寸: 3745*2100*710mm

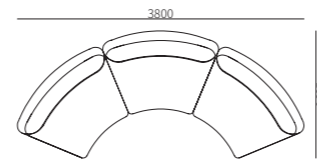

尺寸: 3800*1690*710mm

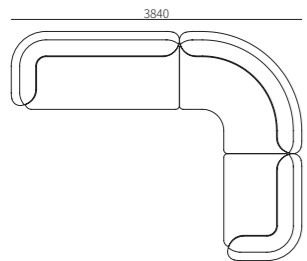

尺寸: 3840*3040*710mm

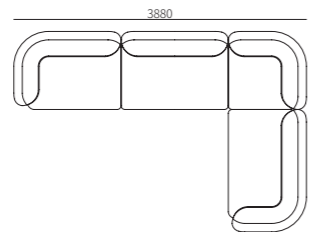

尺寸: 3880*2660*710mm

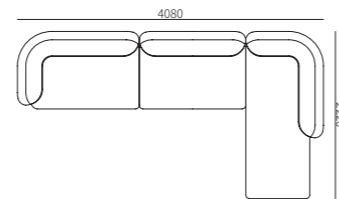

尺寸: 4080*2220*710mm

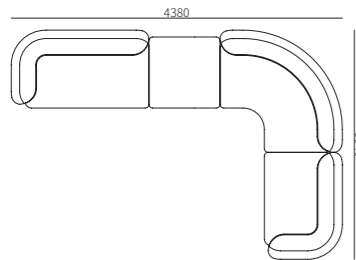

尺寸: 4380*3040*710mm

MELLOW 云端

Ximi Li 李希米



编号: 31F024

产品描述: 沙发整体为布料或牛皮包制, 底脚为黑丝光烤漆金属

PRODUCT DESCRIPTION: Upholstered with fabric or leather. Metal feet in black satin finish

沙发 SOFA

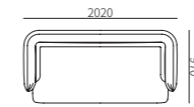

尺寸: 2020*970*770mm
编码: 31F024-12

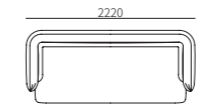

尺寸: 2220*970*770mm
编码: 31F024-13

单扶 LEFT/RIGHT ONE-ARMED SOFA

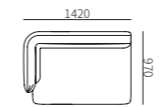

尺寸: 1420*970*770mm
编码: 31F024-21

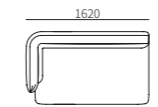

尺寸: 1620*970*770mm
编码: 31F024-22

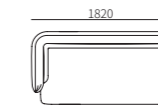

尺寸: 1820*970*770mm
编码: 31F024-23

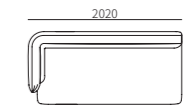

尺寸: 2020*970*770mm
编码: 31F024-24

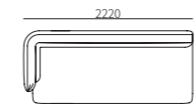

尺寸: 2220*970*770mm
编码: 31F024-25

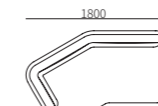

尺寸: 1800*1270*770mm
编码: 31F024-26

单背 SOFA WITHOUT ARM

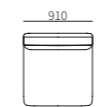

尺寸: 910*970*770mm
编码: 31F024-31

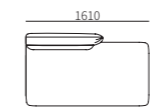

尺寸: 1610*970*770mm
编码: 31F024-71

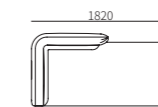

尺寸: 1820*970*770mm
编码: 31F024-41

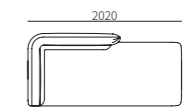

尺寸: 2020*970*770mm
编码: 31F024-42

塌 OTTOMAN

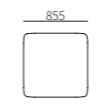

尺寸: 855*855*400mm
编码: 31F024-51

角位 LEFT/RIGHT CORNER SEAT

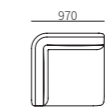

尺寸: 970*970*770mm
编码: 31F024-61

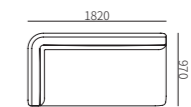

尺寸: 1820*970*770mm
编码: 31F024-62

组合沙发 SECTIONAL SOFA

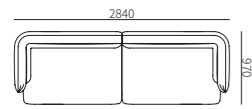

尺寸: 2840*970*770mm

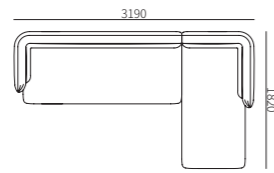

尺寸: 3190*1820*770mm

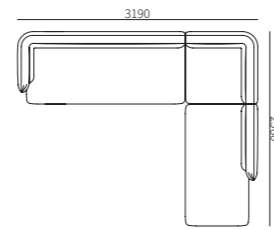

尺寸: 3190*2580*770mm

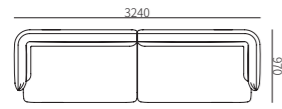

尺寸: 3240*970*770mm

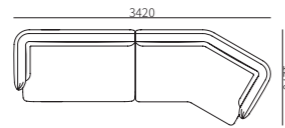

尺寸: 3420*1270*770mm

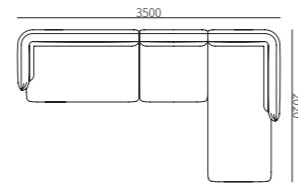

尺寸: 3500*2020*770mm

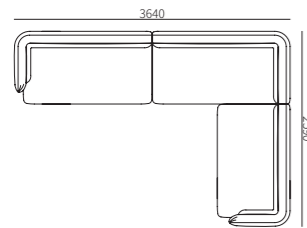

尺寸: 3640*2590*770mm

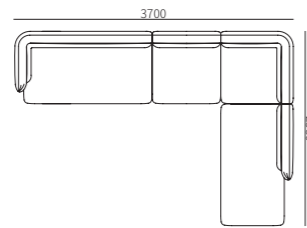

尺寸: 3700*2580*770mm

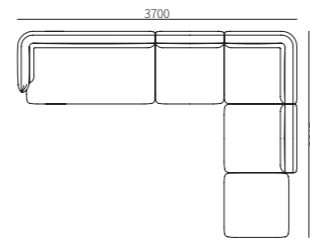

尺寸: 3700*2735*770mm

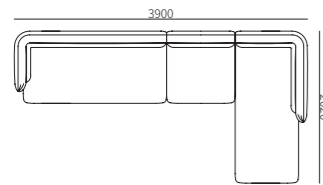

尺寸: 3900*2020*770mm

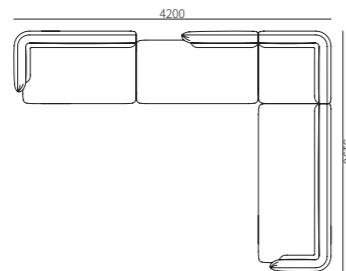

尺寸: 4200*3190*770mm

CÔTE D'AZUR 蓝色海岸
L&L Studio



编号: 31F023

产品描述: 沙发整体为布料或牛皮包制, 底腿为黑灰氟碳漆金属

PRODUCT DESCRIPTION: Upholstered with fabric or leather. Metal feet in dark grey epoxy paint

沙发 SOFA

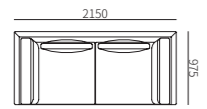

尺寸: 2150*975*740mm
编码: 31F023-12

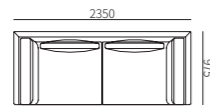

尺寸: 2350*975*740mm
编码: 31F023-13

单扶 LEFT/RIGHT ONE-ARMED SOFA

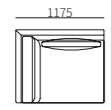

尺寸: 1175*975*740mm
编码: 31F023-21

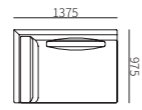

尺寸: 1375*975*740mm
编码: 31F023-22

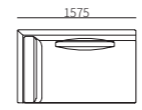

尺寸: 1575*975*740mm
编码: 31F023-23

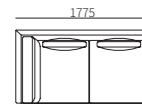

尺寸: 1775*975*740mm
编码: 31F023-24

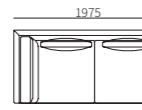

尺寸: 1975*975*740mm
编码: 31F023-25

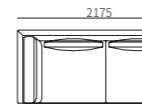

尺寸: 2175*975*740mm
编码: 31F023-26

单背 SOFA WITHOUT ARM

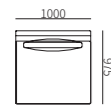

尺寸: 1000*975*740mm
编码: 31F023-31

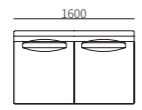

尺寸: 1600*975*740mm
编码: 31F023-32

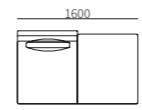

尺寸: 1600*975*740mm
编码: 31F023-71

转角 LEFT/RIGHT CHAISE

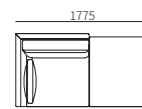

尺寸: 1775*975*740mm
编码: 31F023-41

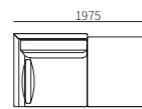

尺寸: 1975*975*740mm
编码: 31F023-42

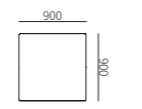

尺寸: 900*900*420mm
编码: 31F023-51

角位 LEFT/RIGHT CORNER SEAT

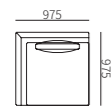

尺寸: 975*975*740mm
编码: 31F023-61

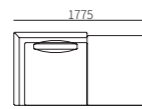

尺寸: 1775*975*740mm
编码: 31F023-62

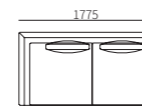

尺寸: 1775*975*740mm
编码: 31F023-63

沙发 SOFA

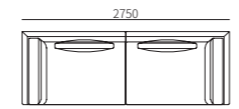

尺寸: 2750*975*740mm

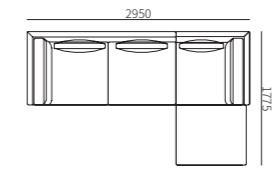

尺寸: 2950*1775*740mm

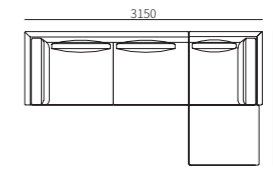

尺寸: 3150*1775*740mm

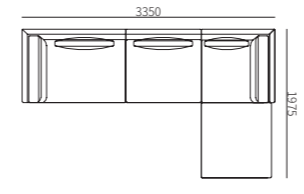

尺寸: 3350*1975*740mm

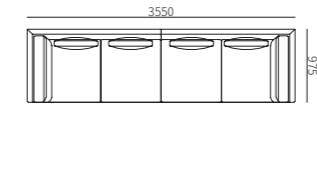

尺寸: 3550*975*740mm

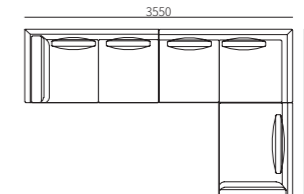

尺寸: 3550*2350*740mm

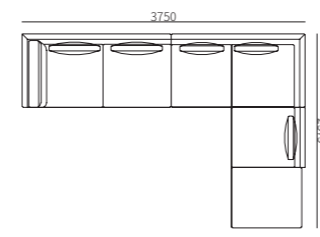

尺寸: 3750*2575*740mm

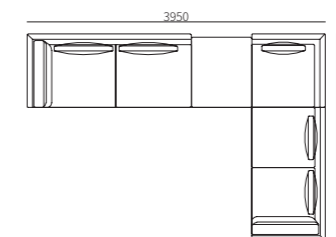

尺寸: 3950*2750*740mm

UOVO 源
Steve Leung 梁志天



编号: 31F006

产品描述: 沙发整体为布料或牛皮包制, 底脚为黑色烤漆金属

PRODUCT DESCRIPTION: Upholstered with fabric or leather. Metal feet in black lacquer finish

沙发 SOFA



单扶 LEFT/RIGHT ONE-ARMED SOFA

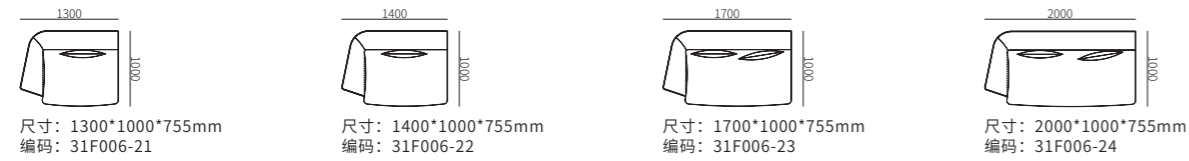

单背 SOFA WITHOUT ARM



转角 LEFT/RIGHT CHAISE

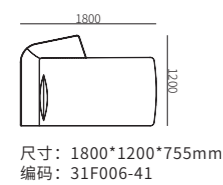

角位 LEFT/RIGHT CORNER SEAT

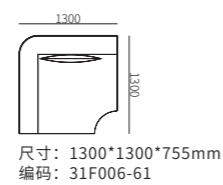

组合沙发 SECTIONAL SOFA

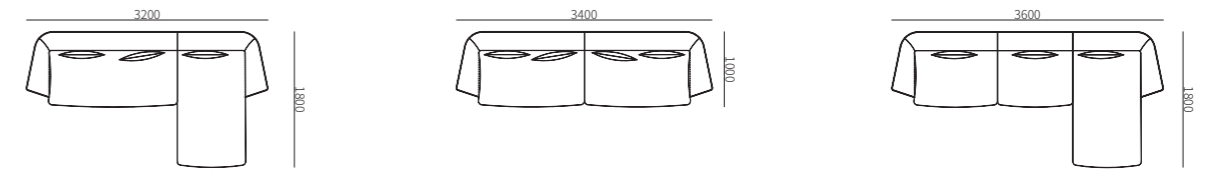

尺寸: 3200*1800*755mm
编码: 31F006ZH-01

尺寸: 3400*1000*755mm
编码: 31F006ZH-02

尺寸: 3600*1800*755mm
编码: 31F006ZH-03

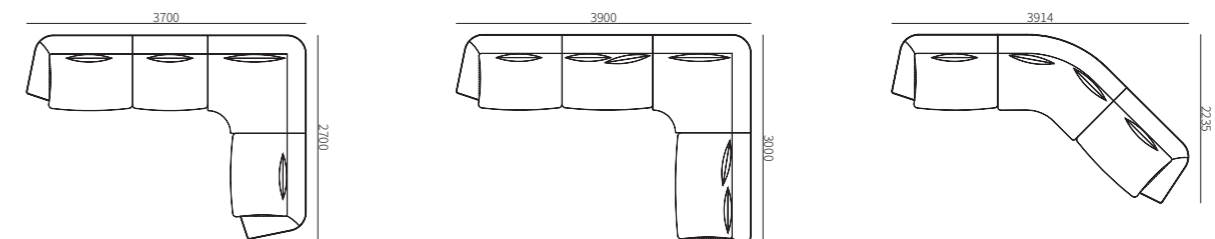

尺寸: 3700*2700*755mm
编码: 31F006ZH-04

尺寸: 3900*3000*755mm
编码: 31F006ZH-05

尺寸: 3914*2235*755mm
编码: 31F006ZH-06

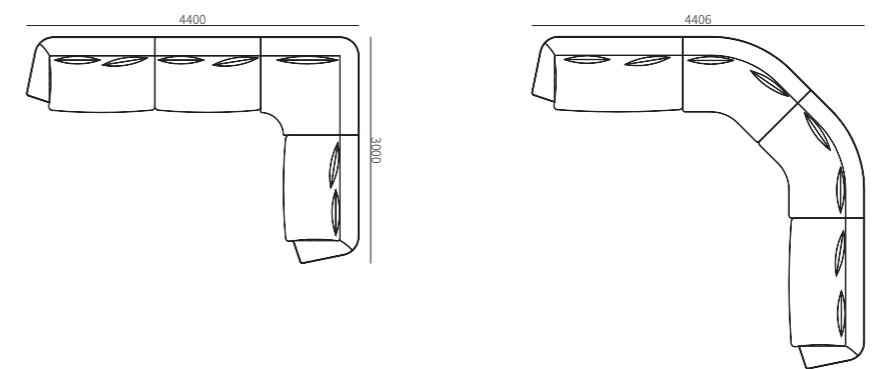

尺寸: 4400*3000*755mm
编码: 31F006ZH-07

尺寸: 4406*4400*755mm
编码: 31F006ZH-08

FIL 风尚
Yonoh



编号: 31F011

产品描述: 沙发整体为布料或牛皮包制, 底脚为黑丝光烤漆金属

PRODUCT DESCRIPTION: Upholstered with fabric or leather. Metal feet in black satin finish

沙发 SOFA

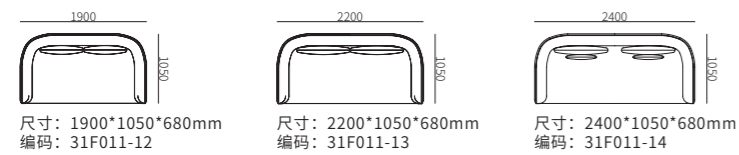

单扶 LEFT/RIGHT ONE-ARMED SOFA

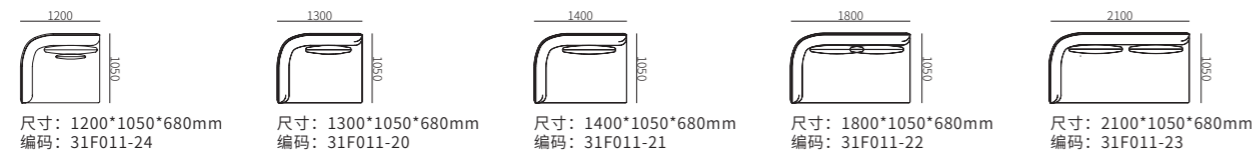

单背 SOFA WITHOUT ARM

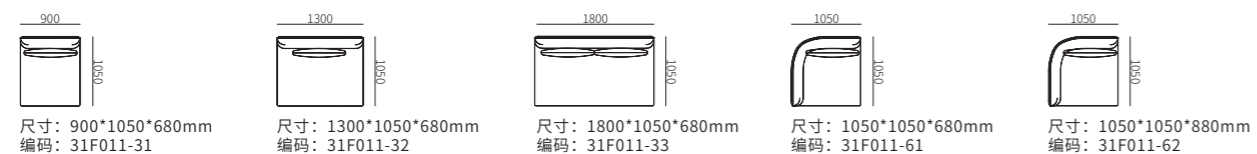

角位 LEFT/RIGHT CORNER SEAT

转角 LEFT/RIGHT CHAISE



墩 OTTOMAN

组合沙发 SECTIONAL SOFA

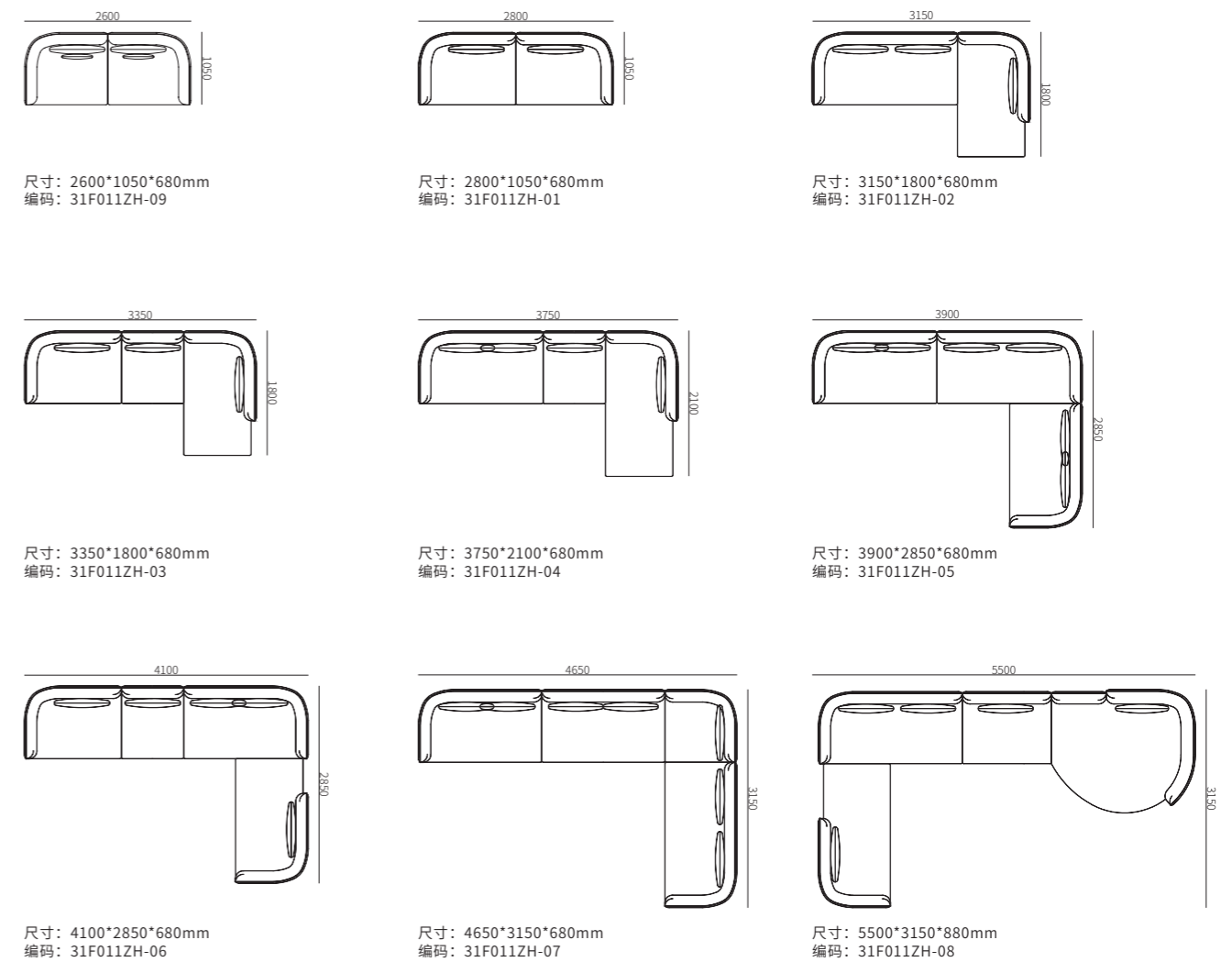

BERLIN 柏林
Sebastian Herkner



编号: 31F016

产品描述: 沙发整体为布料或牛皮包制, 底脚为黑丝光烤漆金属。沙发套可拆洗, 需干洗

PRODUCT DESCRIPTION: Upholstered with fabric or leather. Metal feet in black satin finish. Slipcovers can be removed for dry cleaning

沙发 SOFA

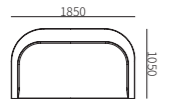

尺寸: 1850*1050*680mm
编码: 31F016-12

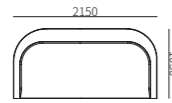

尺寸: 2150*1050*680mm
编码: 31F016-13

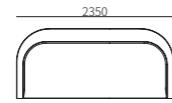

尺寸: 2350*1050*680mm
编码: 31F016-14

单扶 LEFT/RIGHT ONE-ARMED SOFA

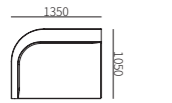

尺寸: 1350*1050*680mm
编码: 31F016-21

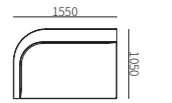

尺寸: 1550*1050*680mm
编码: 31F016-22

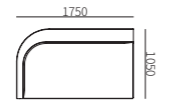

尺寸: 1750*1050*680mm
编码: 31F016-23

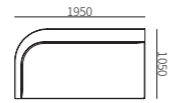

尺寸: 1950*1050*680mm
编码: 31F016-24

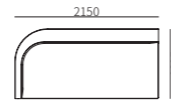

尺寸: 2150*1050*680mm
编码: 31F016-25

单背 SOFA WITHOUT ARM

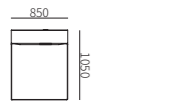

尺寸: 850*1050*680mm
编码: 31F016-31

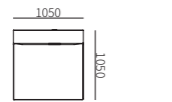

尺寸: 1050*1050*680mm
编码: 31F016-32

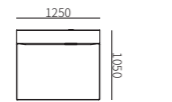

尺寸: 1250*1050*680mm
编码: 31F016-33

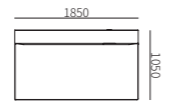

尺寸: 1850*1050*680mm
编码: 31F016-34

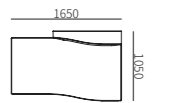

尺寸: 1650*1050*680mm
编码: 31F016-71

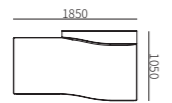

尺寸: 1850*1050*680mm
编码: 31F016-72

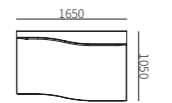

尺寸: 1650*1050*680mm
编码: 31F016-73

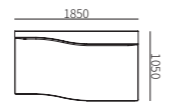

尺寸: 1850*1050*680mm
编码: 31F016-74

转角 LEFT/RIGHT CHAISE

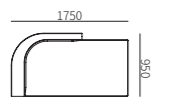

尺寸: 1750*950*680mm
编码: 31F016-41

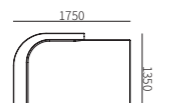

尺寸: 1750*1350*680mm
编码: 31F016-42

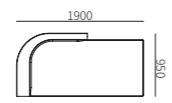

尺寸: 1900*950*680mm
编码: 31F016-43

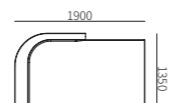

尺寸: 1900*1350*680mm
编码: 31F016-44

榻 OTTOMAN

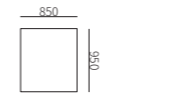

尺寸: 850*950*400mm
编码: 31F016-51

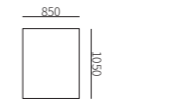

尺寸: 850*1050*400mm
编码: 31F016-52

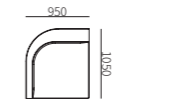

尺寸: 950*1050*680mm
编码: 31F016-61

角位 LEFT/RIGHT CORNER SEAT

组合沙发 SECTIONAL SOFA

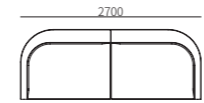

尺寸: 2700*1050*680mm
编码: 31F016ZH-01

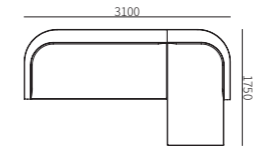

尺寸: 3100*1750*680mm
编码: 31F016ZH-02

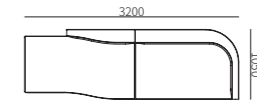

尺寸: 3200*1050*680mm
编码: 31F016ZH-03

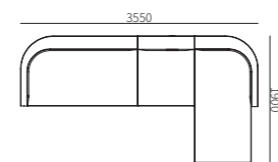

尺寸: 3550*1900*680mm
编码: 31F016ZH-04

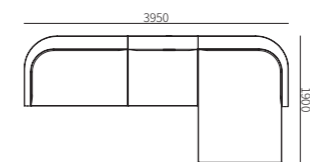

尺寸: 3950*1900*680mm
编码: 31F016ZH-05

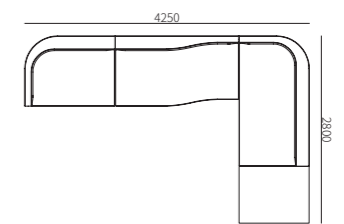

尺寸: 4250*2800*680mm
编码: 31F016ZH-06

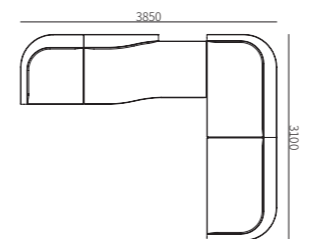

尺寸: 3850*3100*680mm
编码: 31F016ZH-07

MICHEL 米其

Yonoh



编号: 31F009 / 31F015

产品描述: 31F009: 沙发整体为布料或牛皮包制, 底脚为黑丝光烤漆金属。
31F015: 沙发主体为牛皮包制, 坐垫与靠包为布料包制, 底脚为黑丝光烤漆金属 (皮布结合款)

PRODUCT DESCRIPTION: 31F009: Upholstered with fabric or leather. Metal feet in black satin finish. 31F015: Upholstered with leather, cushions in fabric. Metal feet in black satin finish

沙发 SOFA

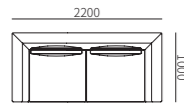

尺寸: 2200*1000*680mm
编码: 31F009 / 31F015-13

单扶 LEFT/RIGHT ONE-ARMED SOFA

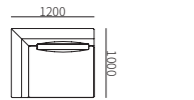

尺寸: 1200*1000*680mm
编码: 31F009 / 31F015-21

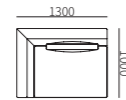

尺寸: 1300*1000*680mm
编码: 31F009 / 31F015-22

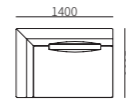

尺寸: 1400*1000*680mm
编码: 31F009 / 31F015-23

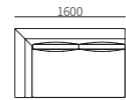

尺寸: 1600*1000*680mm
编码: 31F009 / 31F015-24

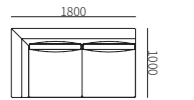

尺寸: 1800*1000*680mm
编码: 31F009 / 31F015-25

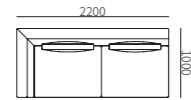

尺寸: 2200*1000*680mm
编码: 31F009 / 31F015-26

单背 SOFA WITHOUT ARM

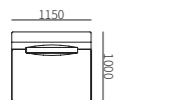

尺寸: 1150*1000*680mm
编码: 31F009 / 31F015-31

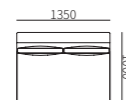

尺寸: 1350*1000*680mm
编码: 31F009 / 31F015-32

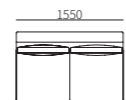

尺寸: 1550*1000*680mm
编码: 31F009 / 31F015-33

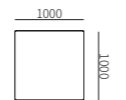

尺寸: 1000*1000*400mm
编码: 31F009 / 31F015-34

墩 OTTOMAN

转角 LEFT/RIGHT CHAISE

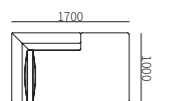

尺寸: 1700*1000*680mm
编码: 31F009 / 31F015-41

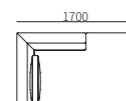

尺寸: 1700*1200*680mm
编码: 31F009 / 31F015-42

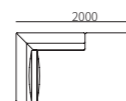

尺寸: 2000*1000*680mm
编码: 31F009 / 31F015-43

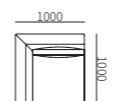

尺寸: 1000*1000*680mm
编码: 31F009 / 31F015-44

角位 LEFT/RIGHT CORNER SEAT

组合沙发 SECTIONAL SOFA

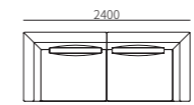

尺寸: 2400*1000*680mm
编码: 31F009ZH / 31F015ZH-01

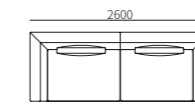

尺寸: 2600*1000*680mm
编码: 31F009ZH / 31F015ZH-10

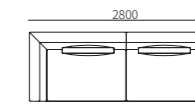

尺寸: 2800*1000*680mm
编码: 31F009ZH / 31F015ZH-02

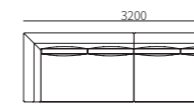

尺寸: 3200*1000*680mm
编码: 31F009ZH / 31F015ZH-03

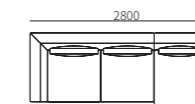

尺寸: 2800*1700*680mm
编码: 31F009ZH / 31F015ZH-04

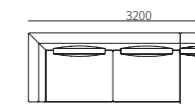

尺寸: 3200*1700*680mm
编码: 31F009ZH / 31F015ZH-05

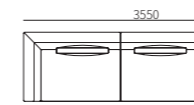

尺寸: 3550*1700*680mm
编码: 31F009ZH / 31F015ZH-06

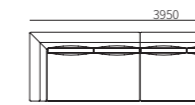

尺寸: 3950*2000*680mm
编码: 31F009ZH / 31F015ZH-07

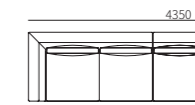

尺寸: 4350*2700*680mm
编码: 31F009ZH / 31F015ZH-08

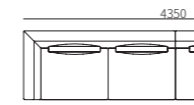

尺寸: 4350*3000*680mm
编码: 31F009ZH / 31F015ZH-09

SHELL 沃野
Frank Chou 周宸宸



编号: 31F017

产品描述: 沙发靠背与底座框为牛皮包制, 扶手与坐垫可选择布料或与靠背, 底座框同色牛皮。底脚为黑灰氟碳漆金属。底框不可拆洗, 其他部分可拆洗, 需干洗

PRODUCT DESCRIPTION: Upholstered with fabric or leather, sofa back and bottom are upholstered in leather only. Metal feet in dark grey epoxy paint finish. Slipcovers (except for bottom frame) can be removed for dry cleaning

沙发 SOFA

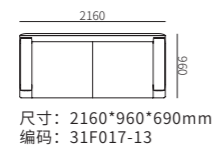
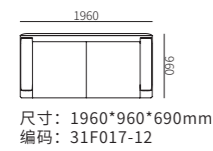

单扶 LEFT/RIGHT ONE-ARMED SOFA

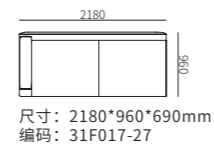
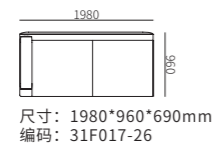
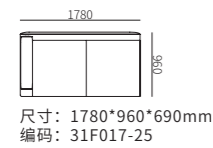
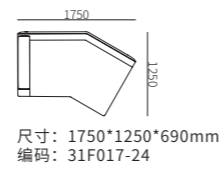
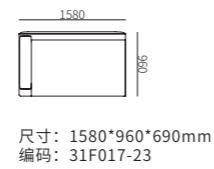
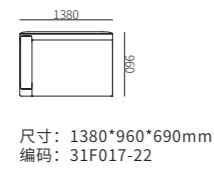
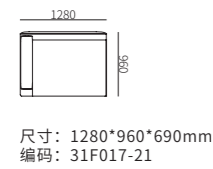

单背 SOFA WITHOUT ARM

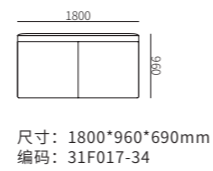
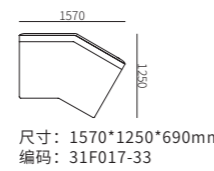
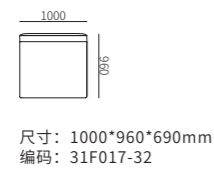
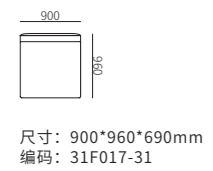

转角 LEFT/RIGHT CHAISE

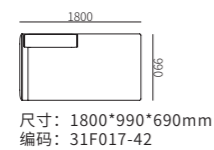
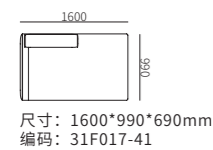

榻 OTTOMAN

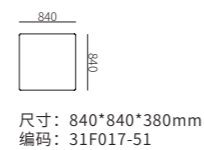

角位 LEFT/RIGHT CORNER SEAT

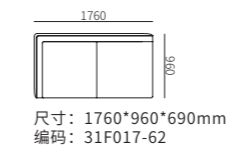
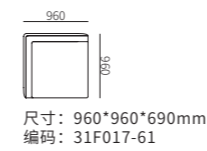

组合沙发 SECTIONAL SOFA

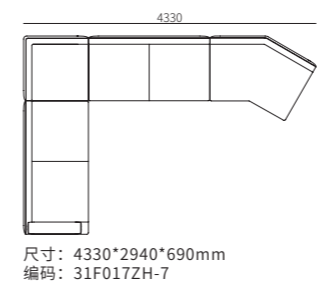
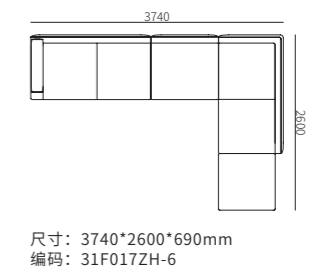
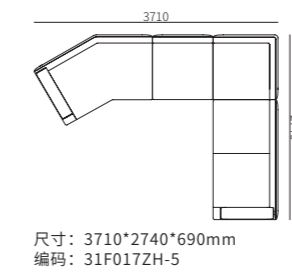
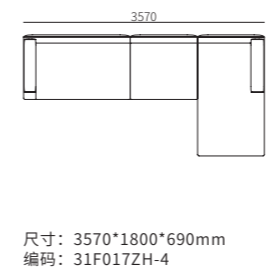
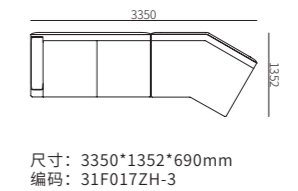
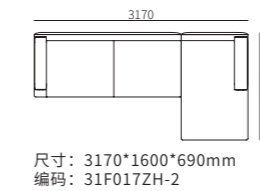
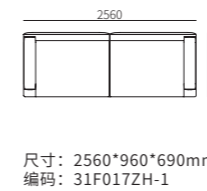

QUADRA 嘉里

Yonoh



编号: 31F008

产品描述: 沙发整体为布料或牛皮包制, 沙发套可拆洗, 需干洗。底框及底脚为黑镜镀膜不锈钢。可添加木制开孔漆储物盒

PRODUCT DESCRIPTION: Upholstered with fabric or leather. Slipcovers can be removed for dry cleaning. Stainless steel frame and feet in black titanium plating. Storage cabinet add on is optional



沙发 SOFA

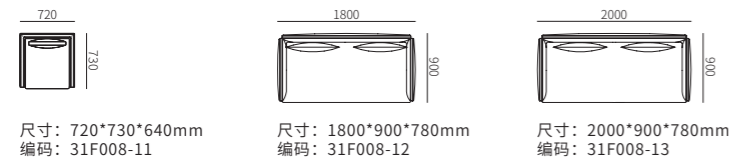

单扶 LEFT/RIGHT ONE-ARMED SOFA

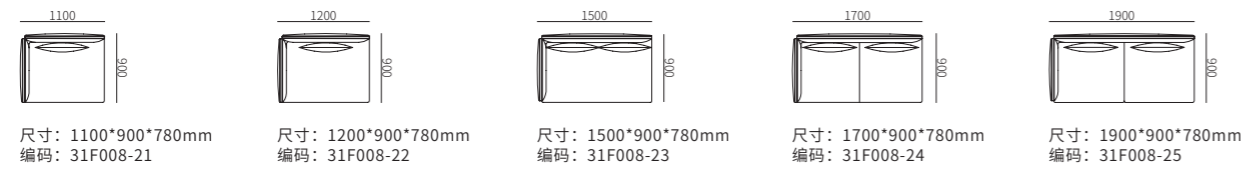

单背 SOFA WITHOUT ARM

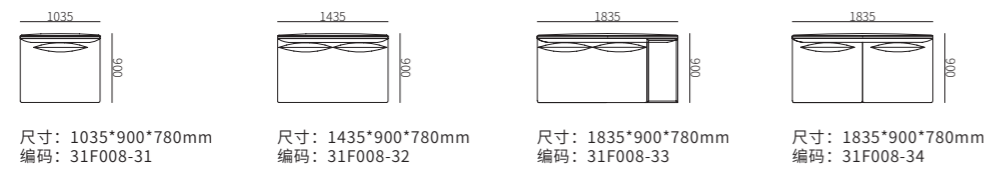

角位 LEFT/RIGHT CORNER SEAT

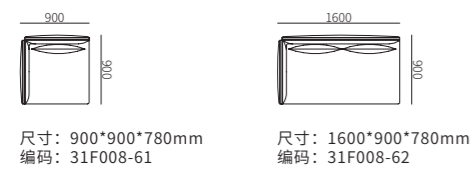

转角 LEFT/RIGHT CHAISE

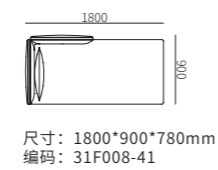

组合沙发 SECTIONAL SOFA



ARMCHAIR

单人位



CALA 朵朵
Yonoh

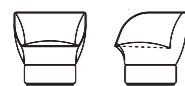

尺寸: 700*700*710mm
编号: 32F004

产品描述: 座椅整体为布料或牛皮包制, 底座可转

PRODUCT DESCRIPTION: Upholstered with fabric or leather. Swivels a full 360 degree

CINI 旖旎
Dainelli Studio

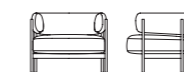

尺寸: 810*730*635mm
编号: 32F012

产品描述: 座椅整体为布料或牛皮包制, 椅腿为不锈钢镀钛

PRODUCT DESCRIPTION: Upholstered with fabric or leather. Stainless steel legs in titanium plating

GIO 山谷
Christophe Delcourt



尺寸: 680*900*800mm
编号: 32F002

产品描述: 座椅整体为布料或牛皮包制, 椅腿为实木烤漆

PRODUCT DESCRIPTION: Upholstered with fabric or leather. Solid wood legs in black lacquer finish

MARGARET 麦格
Sebastian Herkner



尺寸: 700*820*790mm
编号: 32F015

产品描述: 座椅整体为布料或牛皮包制, 底框与脚为黑灰氟碳漆金属

PRODUCT DESCRIPTION: Upholstered with fabric or leather. Metal feet and frame in dark grey epoxy paint finish

DIAMANTE 多德
Archirivolto Design



尺寸: 800*780*800mm
编号: 32F007

产品描述: 座椅整体为布料或牛皮包制, 靠背和扶手的外侧可选与内侧不同布料或牛皮。底架为黑灰氟碳漆, 脚为香槟金镀钛不锈钢

PRODUCT DESCRIPTION: Upholstered with fabric or leather. Outside of the chair back can be selected in different colors from the inside. Metal legs in dark grey epoxy paint finish, feet in Champagne gold titanium plating

BINZ 宾茨
Sebastian Herkner



尺寸: 784*740*733mm
编号: 32F013

产品描述: 座椅整体为布料或牛皮包制, 椅腿为实木开孔漆

PRODUCT DESCRIPTION: Upholstered with fabric or leather. Legs in solid wood

BILLIE 嘉年华
Dainelli Studio

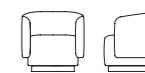

尺寸: 710*660*680mm
编号: 32F016

产品描述: 座椅整体为布料或牛皮包制, 底部为香槟金镀钛不锈钢, 带旋转装置

PRODUCT DESCRIPTION: Upholstered in fabric or leather. Swivel stainless steel base in champagne gold titanium plating

DEBBIE 多彼
Dainelli Studio



尺寸: 700*750*820mm
编号: 32F011

产品描述: 座椅外侧靠背及底框为牛皮包制, 内侧靠背及坐垫为布料或与外侧及底框同色牛皮。底腿为黑灰氟碳漆金属

PRODUCT DESCRIPTION: Upholstered with fabric or leather. Bottom frame, outside of the back in leather only. Metal feet in dark grey epoxy paint finish

UOVO 源
Steve Leung 梁志天



尺寸: 850*850*700mm
编号: 32F006

产品描述: 座椅整体为布料或牛皮包制, 椅腿为实木开孔漆

PRODUCT DESCRIPTION: Upholstered with fabric or leather. Legs in wood

BOL 元阳
Christophe Delcourt

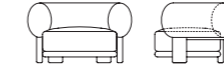

尺寸: 1020*835*632mm
编号: 31F004-11

产品描述: 座椅整体为布料或牛皮包制, 底框与底脚为实木开孔漆

PRODUCT DESCRIPTION: Upholstered with fabric or leather. Frame and feet in solid wood

UOVO 源
Steve Leung 梁志天

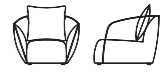

尺寸: 1000*1000*755mm
编号: 31F006-11

产品描述: 座椅整体为布料或牛皮包制, 底脚为黑色烤漆金属

PRODUCT DESCRIPTION: Upholstered with fabric or leather. Metal feet in black lacquer finish

ROLL 卷儿
Minjing Chen (CAFA) 央美陈旻婧



尺寸: 1100*500*620mm
编号: 23F005

产品描述: 座椅整体为布料或牛皮包制, 底腿为黑灰氟碳漆金属

PRODUCT DESCRIPTION: Upholstered with fabric or leather. Metal feet in dark grey epoxy paint finish

QUADRA 嘉里
Yonoh



尺寸: 720*730*640mm
编号: 31F008-11

产品描述: 座椅整体为布料或牛皮包制, 座椅套可拆洗, 需干洗。底框及底脚为黑镜镀钛不锈钢

PRODUCT DESCRIPTION: Upholstered with fabric or leather. Slipcovers can be removed for dry cleaning. Stainless steel frame and feet in black titanium plating

COFFEE TABLE

茶几



CRI 可瑞
Archirivolto Design

尺寸: D1248*335mm
D1048*335mm
编号: 41C001 / 41C002

产品描述: 茶几桌面为大理石或木面, 金属腿为香槟金镀钛不锈钢

PRODUCT DESCRIPTION: Table top in marble or wood, Stainless steel frame in champagne gold titanium plating

FUNGI 松露
Santiago Sevillano



尺寸: D1200*345mm
D1000*345mm
编号: 41C033 / 41C034

产品描述: 茶几桌面为木制开孔漆或岩板。底部为玻璃钢烤漆

PRODUCT DESCRIPTION: Table top in wood or stone. Bottom in colored lacquer finish

GATHER 汇
Ximi Li 李希米



尺寸: 1400*800*365mm
1200*1200*365mm
更多尺寸详见官网
编号: 41C035 / 41C036

产品描述: 茶几桌面为岩板或木质开孔漆。金属架为黑镜镀钛不锈钢。立板为烤漆。底座和抽屉柜为木制开孔漆

PRODUCT DESCRIPTION: Table top in stone or wood. Stainless steel frame in black titanium plating. Side panel in colored lacquer finish. Drawer and bottom panel in wood

GRANTORINO 都灵
Dainelli Studio



尺寸: 1400*1000*320mm
1200*900*320mm
1000*700*320mm
编号: 41C024 / 41C025

产品描述: 茶几桌面为大理石或木面, 金属腿为黑灰氟碳漆

PRODUCT DESCRIPTION: Table top in marble or wood. Metal frame in dark grey epoxy paint finish

DAWN 晓
Ximi Li 李希米



尺寸: D1250*358mm
D1050*358mm
编号: 41C031

产品描述: 茶几桌面为岩板, 框架为黑灰氟碳漆金属

PRODUCT DESCRIPTION: Table top in stone. Metal frame in dark grey epoxy paint finish

GRASSI 格萨
Sebastian Herkner

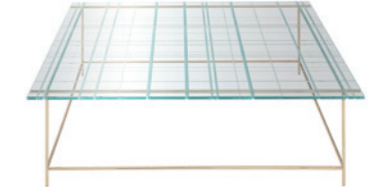

尺寸: 1400*660*360mm
1200*1200*360mm
更多尺寸详见官网
编号: 41C023

产品描述: 茶几桌面为工艺钢化玻璃, 金属腿为镀钛不锈钢

PRODUCT DESCRIPTION: Table top in tempered glass. Stainless steel frame in titanium plating

UOVO 源
Steve Leung 梁志天



尺寸: 1400*1200*320mm
编号: 41C010

产品描述: 茶几桌面为大理石或木面, 底腿为实木开孔漆

PRODUCT DESCRIPTION: Table top in marble or wood. Legs in solid wood

PLAN 普兰
Archirivolto Design

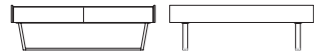

尺寸: 1400*1400*373mm
1400*700*373mm
更多尺寸详见官网
编号: 41C006 / 41C009

产品描述: 茶几桌面为大理石或木面, 金属腿为黑灰氟碳漆

PRODUCT DESCRIPTION: Table top in marble or wood. Metal frame in dark grey epoxy paint finish

GENIE 珍尼
L&L Studio

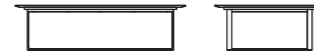

尺寸: 1400*900*382mm
D600*510mm
更多尺寸详见官网
编号: 41C016 / 41C017

产品描述: 方茶几桌面为大理石, 底板为木制开孔漆, 金属框为黑灰氟碳漆。圆茶几桌面为木制开孔漆, 框架为黑灰氟碳漆

PRODUCT DESCRIPTION: Rectangular table top in marble, bottom panel in wood. Metal frame in dark grey epoxy paint finish. Round table top in wood. Metal frame in dark grey epoxy paint finish

CHESS 纤纤
L&L Studio

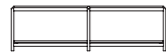

尺寸: D1200*350mm
D1000*350mm
编号: 41C029 / 41C030

产品描述: 茶几桌面为木制开孔漆或岩板, 底部隔板为木制开孔漆, 框架为镀钛不锈钢

PRODUCT DESCRIPTION: Table top in wood or stone, bottom panel in wood only. Stainless steel frame in titanium plating

CHESS 纤纤
L&L Studio

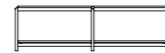

尺寸: 1200*1200*350mm
1400*900*350mm
编号: 41C026 / 41C027

产品描述: 茶几桌面为木制开孔漆或岩板, 底部隔板为木制开孔漆, 框架为镀钛不锈钢

PRODUCT DESCRIPTION: Table top in wood or stone, bottom panel in wood only. Stainless steel frame in titanium plating

TILE 泰然
Yonoh

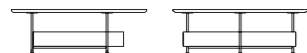

尺寸: D1200*400mm
编号: 41C011/41C012

产品描述: 茶几桌面为大理石或木制开孔漆, 底部收纳区为黑灰氟碳漆, 金属框为黑灰氟碳漆, 底脚为金色镀钛

PRODUCT DESCRIPTION: Table top in marble or wood. Storage metal box in dark grey epoxy paint finish. Metal frame in dark grey epoxy paint finish and gold titanium plating feet

SPHENOID 蝴蝶骨
Hongyu Chen (CAFA) 央美陈虹宇



尺寸: D1000*360mm
编号: 41C032

产品描述: 茶几桌面为黑色玻璃, 主体为烤漆

PRODUCT DESCRIPTION: Table top in black color glass. Bottom in colored lacquer finish

SIDE TABLE

边几



STAGE 云台
Sebastian Herkner



尺寸: 360*360*460mm
编号: 42C010

产品描述: 角几整体为木制开孔漆

PRODUCT DESCRIPTION: Made in solid wood

FUNGI 松露
Santiago Sevillano



尺寸: D500*500mm
编号: 42C014 / 42C015

产品描述: 角几桌面为木制开孔漆或岩板。底部为玻璃钢烤漆

PRODUCT DESCRIPTION: Table top in wood or stone. Bottom in colored lacquer finish

DAWN 晓
Ximi Li 李希米



尺寸: D500*500mm
编号: 42C013

产品描述: 角几桌面为棕色 PU 马鞍皮。框架为黑灰氟碳漆金属

PRODUCT DESCRIPTION: Table top in brown saddle leather. Metal frame in dark grey epoxy paint finish

GATHER 汇
Ximi Li 李希米

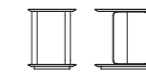

尺寸: 400*550*502mm
400*550*505mm
编号: 42C016 / 42C017

产品描述: 角几桌面为岩板或木质开孔漆。金属架为黑镜镀钛不锈钢。立板为烤漆。底座为木制开孔漆

PRODUCT DESCRIPTION: Table top in stone or wood. Stainless steel frame in black titanium plating. Side panel in colored lacquer finish. Bottom panel in wood

CONE 科恩
Sebastian Herkner

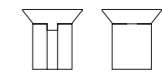

尺寸: D460*460mm
编号: 42C009

产品描述: 角几桌面为中花白大理石, 底座为不锈钢镀铜拉丝

PRODUCT DESCRIPTION: Table top in venato white marble, stainless steel base in brushed brass finish

CRI 可瑞
Archirivolto Design



尺寸: D648*449mm
编号: 41C002-03 / 41C001-03

产品描述: 角几桌面为大理石或木面, 金属腿为香槟金镀钛不锈钢

PRODUCT DESCRIPTION: Table top in marble or wood, Stainless steel frame in champagne gold titanium plating

ZEN 冰心
Hans Sandgren Jakobsen



尺寸: D354*404mm
编号: 42C003

产品描述: 角几整体为镀钛不锈钢

PRODUCT DESCRIPTION: Table made in stainless steel with titanium plating

OVO 星空
Christophe Delcourt

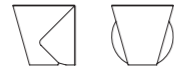

尺寸: 450*450*450mm
编号: 41C007

产品描述: 角几主体为黑色烤漆玻璃钢, 顶圆与侧面为杉绿色烤漆
PRODUCT DESCRIPTION: Table made in FRP integrated molding in black lacquered finish, top and side surface in green lacquered finish

GRANTORINO 都灵
Dainelli Studio



尺寸: 500*500*520mm
编号: 42C007 / 42C008

产品描述: 角几桌面为大理石或木面, 金属腿为黑灰氟碳漆
PRODUCT DESCRIPTION: Table top in marble or wood. Metal frame in dark grey epoxy paint finish

COSMO 魔方
Masayuki Kurokawa 黑川雅之



尺寸: 400*400*400mm
编号: 71C001

产品描述: 角几整体为镀钛不锈钢
PRODUCT DESCRIPTION: Table made in stainless steel with titanium plating

TILE 泰然
Yonoh

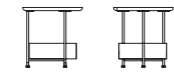

尺寸: D500*500mm
编号: 41C011-02 / 41C012-02

产品描述: 茶几桌面为大理石或木制开孔漆, 底部收纳区为黑灰氟碳漆, 金属框为黑灰氟碳漆, 底脚为金色镀钛
PRODUCT DESCRIPTION: Table top in marble or wood. Storage metal box in dark grey epoxy paint finish. Metal frame in dark grey epoxy paint finish and gold titanium plating feet

CHESS 纤纤
L&L Studio

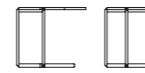

尺寸: 600*380*520mm
编号: 42C011

产品描述: 角几桌面为木制开孔漆或岩板, 框架为镀钛不锈钢
PRODUCT DESCRIPTION: Table top in wood or stone. Stainless steel frame in titanium plating

CONSOLE 条案

GRANTORINO 都灵
Dainelli Studio

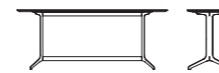

尺寸: 1800*450*500mm
1500*450*500mm
编号: 43C004 / 43C005

产品描述: 条案桌面为大理石或木面, 金属腿为黑灰氟碳漆
PRODUCT DESCRIPTION: Table top in marble or wood. Metal frame in dark grey epoxy paint finish

LARGO 罗曼
P&P Studio

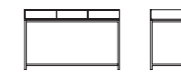

尺寸: 1800*400*850mm
1500*400*850mm
编号: 13C001

产品描述: 桌面与抽屉柜为木制开孔漆, 底架为黑镜镀钛不锈钢
PRODUCT DESCRIPTION: Table top and drawers in wood. Stainless steel frame in black titanium plating

PLUS 佳怡
Ximi Li 李希米

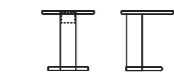

尺寸: D470*540mm
编号: 42C005

产品描述: 角几主体为木制开孔漆, 底脚为香槟金镀钛不锈钢
PRODUCT DESCRIPTION: Table made in wood, stainless steel base in champagne gold titanium plating

LAYER 云层
Santiago Sevillano



尺寸: 950*450*530mm
700*475*530mm
编号: 41C008

产品描述: 角几桌面为大理石, 框架为香槟金镀钛不锈钢
PRODUCT DESCRIPTION: Table top in marble. Stainless steel frame in champagne gold titanium plating

MOON 尚月
L&L Studio

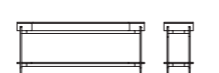

尺寸: 1800*420*850mm
1500*420*850mm
1200*420*850mm
编号: 13C003

产品描述: 桌面为木制开孔漆, 底架为镀钛不锈钢
PRODUCT DESCRIPTION: Table top in wood. Stainless steel frame in titanium plating

MOON 尚月
L&L Studio



尺寸: 1600*420*600mm
1400*420*600mm
1200*420*600mm
编号: 43C003

产品描述: 条案桌面为木制开孔漆, 桌面一端镶嵌圆形岩板。底架为镀钛不锈钢
PRODUCT DESCRIPTION: Table top in wood with stone insert. Stainless steel frame in titanium plating

LIVING CABINET

电视柜



RHYTHM 半岛
L&L Studio

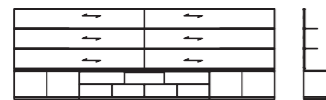

带背板 WITH BACK PANELS

尺寸: 4800*472*1664mm 4200*472*1664mm
3600*472*1664mm 3300*472*1664mm
3000*472*1664mm 2700*472*1664mm
编号: 52C004



不带背板 WITHOUT BACK PANELS

尺寸: 4200*472*528mm 3600*472*528mm
3300*472*528mm 3000*472*528mm
2700*472*528mm

产品描述: 电视柜柜体与背板为木制开孔漆, 背板铝合金黑丝光烤漆封边, 金属黑丝光烤漆层板, 底柜台面为大理石, 底柜门板和抽屉面为烤漆

PRODUCT DESCRIPTION: Storage cabinet and back panel in wood. Back with metal edge banding in black satin finish. Storage cabinet with top in marble, door and drawers front in color lacquer finish

RHYTHM 半岛
L&L Studio



尺寸: 1200*500*630mm
900*500*630mm
编号: 52C009

产品描述: 电视柜主体为木制开孔漆, 底脚为黑灰氟碳漆

PRODUCT DESCRIPTION: TV stand made in wood with metal feet in dark grey epoxy paint finish

STRATA 斯巴达
Studio Roderick Vos

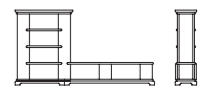

尺寸: 3760*450*1542mm
3460*450*1542mm
3160*450*1542mm
2860*450*1542mm
编号: 52C010

产品描述: 电视柜整体烤漆

PRODUCT DESCRIPTION: Cabinet in colored lacquer finish

STRATA 斯巴达
Studio Roderick Vos



尺寸: 3206*450*512mm
2806*450*512mm
2406*450*512mm
2006*450*512mm
1806*450*512mm
编号: 52C008

产品描述: 电视柜整体烤漆

PRODUCT DESCRIPTION: Made in wood with colored lacquer finish

LARGO 罗曼
L&L Studio



尺寸: 2358*490*500mm
2138*490*500mm
1860*490*500mm
编号: 52C006

产品描述: 电视柜主体为开孔漆, 金属底腿为黑镜镀钛不锈钢, 抽屉上方开房区内置烤漆装饰盒

PRODUCT DESCRIPTION: Made in wood with stainless steel legs in black titanium plating. Colored lacquer box inside the opening area

LONJA 龙佳
Santiago Sevillano



尺寸: 2400*400*500mm
2000*400*500mm
编号: 52C001

产品描述: 电视柜主体为木制开孔漆, 顶面为大理石, 金属腿为香槟金镀钛不锈钢

PRODUCT DESCRIPTION: Made in wood with marble top. Stainless steel legs in champagne gold titanium plating



餐厅

Dining Room

DINING TABLE

餐桌



REMBRANT 玲珑
Achirivolto Design



尺寸: 2400*1100*750mm
2200*1100*750mm
2000*1100*750mm
1800*1000*750mm
1600*1000*750mm
编号: 11C013

产品描述: 餐桌桌面为大理石, 底架为香槟金镀钛不锈钢或者黑灰氟碳漆金属

PRODUCT DESCRIPTION: Dining table top in marble. Stainless steel base in champagne gold titanium plating or metal base in dark grey epoxy paint finish

SIFF 江月
Christophe Delcourt

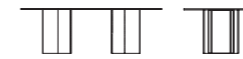

尺寸: 2300*1100*740mm
1800*1100*740mm
更多尺寸详见官网
编号: 11C001

产品描述: 餐桌桌面为灰色钢化玻璃, 底腿为灰色钢化玻璃结合木制开孔漆

PRODUCT DESCRIPTION: Dining table top in grey tempered glass. Base in the same tempered glass and wood

BOW 联
Ximi Li 李希米

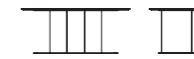

尺寸: 2400*1000*750mm
1800*900*750mm
更多尺寸详见官网
编号: 11C020

产品描述: 餐桌桌面为大理石或木制开孔漆, 底座内侧为香槟金镀钛不锈钢, 外侧为黑灰氟碳漆金属

PRODUCT DESCRIPTION: Table top in marble or wood. Bottom in dark grey epoxy paint metal and champagne gold titanium plating

GRID 格韵
Ximi Li 李希米



尺寸: 2600*1000*740mm
1600*900*740mm
更多尺寸详见官网
编号: 11C021 / 11C025

产品描述: 餐桌桌面为木制开孔漆或岩板, 底架为克莱茵蓝或黑灰氟碳漆金属

PRODUCT DESCRIPTION: Table top in wood or stone. Metal frame in Klein blue or dark grey epoxy paint finish

FUGUE 富笛
Frank Chou 周宸宸



尺寸: 2400*1000*750mm
1600*900*750mm
更多尺寸详见官网
编号: 11C017 / 11C018

产品描述: 餐桌可选大理石桌面搭配实木开孔漆或黑色烤漆桌腿或整体桌面与桌腿为木制开孔漆

PRODUCT DESCRIPTION: Dining table top in marble or wood. Legs in solid wood

FLU 芙蓉
Archirivolto Design



尺寸: 2400*1100*750mm
1600*1000*750mm
更多尺寸详见官网
编号: 11C015

产品描述: 餐桌桌面为大理石或木制开孔漆, 桌腿为实木烤漆

PRODUCT DESCRIPTION: Dining table top in marble or wood. Solid wood legs in colored lacquer finish

GAUDI 高迪
Archirivolto Design



尺寸: D1800*740mm
D1600*740mm
编号: 11C019

产品描述: 餐桌桌面为木制开孔漆, 搭配大理石或烤漆转盘, 底座为镜面不锈钢

PRODUCT DESCRIPTION: Dining table top in wood with lazy susan in marble or colored lacquer finish. Stainless steel in mirror finish

MIAMI 迈阿密
Archirivolto Design



尺寸: D1800*750mm
D1600*750mm
更多尺寸详见官网
编号: 11C003 / 11C004

产品描述: 餐桌桌面可选大理石搭配同色大理石底座或木制开孔漆桌面搭配中花白大理石底座。可选大理石或烤漆转盘, 金属框为香槟金镀钛不锈钢

PRODUCT DESCRIPTION: Dining table is optional in Marble top with the same base panel or wood top with venato white marble base panel. Lazy susan is optional in marble or colored lacquer finish. Stainless steel frame in champagne gold titanium plating

POCKY 百吉
Frank Chou 周宸宸



尺寸: D1800*740mm
D1400*740mm
编号: 11C022 / 11C023

产品描述: 餐桌桌面为大理石或木制开孔漆, 底腿为烤漆。餐桌可外置转盘

PRODUCT DESCRIPTION: Table top in marble or wood. Bottom in colored lacquer finish. Lazy susan is available

CHAIR

椅子



LIME 琳云
Archiribolto Design



尺寸: 455*575*850mm
编号: 21F009

产品描述: 座椅整体为布料或牛皮包制, 椅腿为黑灰氟碳漆金属

PRODUCT DESCRIPTION: Upholstered with fabric or leather. Metal Legs in dark grey epoxy paint finish

NIVES 彼岸
Archirivolto Design



尺寸: 580*600*790mm
编号: 21F015

产品描述: 座椅为布料或牛皮包制, 椅腿为黑灰氟碳漆金属

PRODUCT DESCRIPTION: Upholstered with fabric or leather. Metal legs in dark grey epoxy paint finish

MELLOW 云端
Ximi Li 李希米

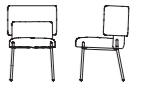

尺寸: 520*540*800mm
编号: 21F013

产品描述: 座椅为布料或牛皮包制, 椅腿为黑灰氟碳漆金属

PRODUCT DESCRIPTION: Upholstered with fabric or leather. Metal legs in dark grey epoxy paint finish

NAO 尼奥
Archirivolto Design



尺寸: 446*568*890mm
编号: 21F012

产品描述: 座椅整体为布料或牛皮包制, 椅腿为实木开孔漆

PRODUCT DESCRIPTION: Upholstered with fabric or leather. Legs in solid wood

NAO 尼奥
Archirivolto Design



尺寸: 446*568*810mm
编号: 21F008

产品描述: 座椅整体为布料或牛皮包制, 椅腿为实木开孔漆

PRODUCT DESCRIPTION: Upholstered with fabric or leather. Legs in solid wood

NARA 秋叶
Archirivolto Design



尺寸: 560*610*800mm
编号: 21F017

产品描述: 座椅为布料或牛皮包制, 椅腿为实木开孔漆

PRODUCT DESCRIPTION: Upholstered with fabric or leather. Legs in solid wood

NARA 秋叶
Archirivolto Design



尺寸: 560*610*800mm
编号: 21F016

产品描述: 座椅为布料或牛皮包制, 椅腿为黑灰氟碳漆金属

PRODUCT DESCRIPTION: Upholstered with fabric or leather. Metal legs in dark grey epoxy paint finish

AGATA 稻香
Archirivolto Design



尺寸: 524*588*845mm
编号: 21F014

产品描述: 座椅为布料或牛皮包制, 椅腿为实木开孔漆

PRODUCT DESCRIPTION: Upholstered with fabric or leather. Legs in solid wood

ENCONTRA 轻舟
L&L Studio



尺寸: 500*590*850mm
编号: 21F005

产品描述: 座椅整体为布料或牛皮包制, 椅腿为实木开孔漆

PRODUCT DESCRIPTION: Upholstered with fabric or leather. Legs in solid wood

HELLO 哈罗
L&L Studio

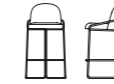

尺寸: 485*495*1000mm
485*495*900mm
编号: 25F001

产品描述: 整体为布料或牛皮包制, 椅腿为黑灰氟碳漆或镀钛不锈钢

PRODUCT DESCRIPTION: Upholstered with fabric or leather. Metal Legs in dark grey epoxy paint finish or stainless steel legs in titanium plating

CHIP 齐贝
Yonoh



尺寸: 539*525*772mm
编号: 21F010

产品描述: 座椅整体为布料或牛皮包制, 椅腿为黑灰氟碳漆金属, 底脚为香槟金镀钛不锈钢

PRODUCT DESCRIPTION: Upholstered with fabric or leather. Metal Legs in dark grey epoxy paint finish, feet in champagne gold titanium plating

BOLA 飞燕
Yonoh



尺寸: 600*560*775mm
编号: 21F003

产品描述: 座椅整体为布料或牛皮包制, 椅腿为黑丝光烤漆, 底脚为香槟金镀钛不锈钢

PRODUCT DESCRIPTION: Upholstered with fabric or leather. Metal Legs in black satin finish, feet in champagne gold titanium plating

PRISMA 万象
Studio Roderick Vos

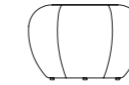
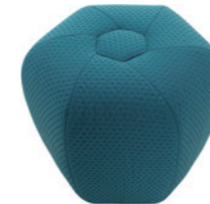

尺寸: 1000*866*400mm
800*693*400mm
600*519*400mm
500*433*450mm
编号: 23F004

产品描述: 座椅整体为 Marshmallow 系列布料包制, 底脚为黑丝光烤漆金属

PRODUCT DESCRIPTION: Upholstered with fabric from the Marshmallow collection. Metal feet in black satin finish

PULO 布丁
Archirivolto Design

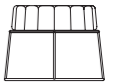

尺寸: D600*450mm
D500*500mm
编号: 23F001

产品描述: 座椅整体为布料或牛皮包制, 椅腿为黑丝光烤漆金属或香槟金镀钛不锈钢

PRODUCT DESCRIPTION: Upholstered with fabric or leather. Metal Legs in black satin finish or champagne gold titanium plating

OHO 燕亭
Christophe Delcourt



尺寸: 500*580*800mm
编号: 21F001

产品描述: 座椅整体为布料或牛皮包制, 椅腿为实木开孔漆

PRODUCT DESCRIPTION: Upholstered with fabric or leather. Legs in solid wood

UOVO 源
Steve Leung 梁志天



尺寸: 660*630*650mm
编号: 22F001

产品描述: 座椅整体为布料或牛皮包制, 椅腿为实木开孔漆

PRODUCT DESCRIPTION: Upholstered with fabric or leather. Legs in solid wood

LONJA 龙佳
Santiago Sevillano

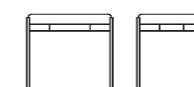

尺寸: 516*416*450mm
编号: 23F002

产品描述: 座椅整体为布料或牛皮包制, 椅腿为香槟金镀钛不锈钢

PRODUCT DESCRIPTION: Upholstered with fabric or leather. Legs in Champagne gold titanium plating

SIDEBOARD

餐边柜



STRATA 斯巴达
Studio Roderick Vos

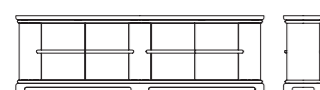

尺寸: 3206*450*852mm
2806*450*852mm
2406*450*852mm
2006*450*852mm
1806*450*852mm
编号: 51C011

产品描述: 边柜整体烤漆

PRODUCT DESCRIPTION: Made in wood with colored lacquer finish

LEVHIA 璃影
Dainelli Studio

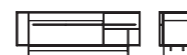

尺寸: 2000*517*730mm
编号: 51C012

产品描述: 主体框架为灰黑钢化玻璃, 柜体为木制开孔漆

PRODUCT DESCRIPTION: Frame in dark grey tempered glass, drawers in wood

RITA 瑞达
L&L Studio



尺寸: 2400*500*800mm
2000*500*800mm
1800*500*800mm
编号: 51C009

产品描述: 边柜主体为木制开孔漆, 金属底腿为黑灰氟碳漆

PRODUCT DESCRIPTION: Made in wood with metal legs in dark grey epoxy paint finish

LONJA 龙佳
Santiago Sevillano



尺寸: 2200*450*800mm
2000*450*800mm
编号: 51C001

产品描述: 边柜主体为木制开孔漆, 顶面为大理石, 金属腿为香槟金镀钛不锈钢

PRODUCT DESCRIPTION: Made in wood with marble top. Stainless steel legs in champagne gold titanium plating

LONJA 龙佳
Santiago Sevillano

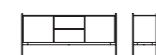

尺寸: 2200*466*862mm
1800*466*862mm
1600*466*862mm
编号: 51C003

产品描述: 边柜主体为木制开孔漆, 顶面为大理石, 金属腿为香槟金镀钛不锈钢

PRODUCT DESCRIPTION: Made in wood with marble top. Stainless steel legs in champagne gold titanium plating

LARGO 罗曼
P&P Studio

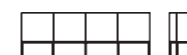

尺寸: 2000*500*750mm
1800*500*750mm
1500*500*750mm
编号: 51C004

产品描述: 边柜主体为木制开孔漆, 底腿为黑镜镀钛不锈钢

PRODUCT DESCRIPTION: Made in wood with stainless steel legs in black titanium plating

RITA 瑞达
L&L Studio



尺寸: 1200*454*1500mm
编号: 51C010

产品描述: 酒柜主体为木制开孔漆, 开放区域内置烤漆内盒, 底脚为黑灰氟碳漆金属

PRODUCT DESCRIPTION: Wine cabinet made in wood. Colored lacquer box inside the opening area. Metal feet in dark grey epoxy paint finish



卧室

Bedroom

BED & BEDSIDE TABLE

床 & 床头柜



UOVO 源
Steve Leung 梁志天

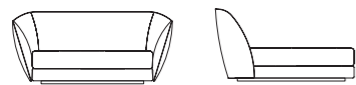

尺寸: 2550*2285*1080mm (床垫 2000*2000mm) 2350*2285*1080mm (床垫 1800*2000mm)
2150*2285*1080mm (床垫 1600*2000mm) 2050*2285*1080mm (床垫 1500*2000mm)
编号: 61F002

产品描述: 床为布料或牛皮包制, 床脚为实木开孔漆

PRODUCT DESCRIPTION: Upholstered with fabric or leather, feet in solid wood

BARRY 百瑞
Ximi Li 李希米

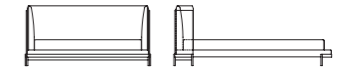

尺寸: 2325*2293*1050mm (床垫 2000*2000mm)
2125*2293*1050mm (床垫 1800*2000mm)
1925*2293*1050mm (床垫 1600*2000mm)
1825*2293*1050mm (床垫 1500*2000mm)
编号: 61F010 / 61F011

产品描述: 床外侧为牛皮包制, 床内侧与床望可选择面料或外侧同色牛皮。床脚为黑灰氟碳漆金属

PRODUCT DESCRIPTION: Upholstered with fabric or leather, outside of the back in leather only. Metal feet in dark grey epoxy paint finish

MELLOW 云端
Ximi Li 李希米

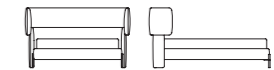

尺寸: 2420*2215*1100mm (床垫 2000*2000mm)
2220*2215*1100mm (床垫 1800*2000mm)
1920*2215*1100mm (床垫 1500*2000mm)
1620*2215*1100mm (床垫 1200*2000mm)
编号: 61F013

产品描述: 床为布料或牛皮包制, 床腿为黑灰氟碳漆金属

PRODUCT DESCRIPTION: Upholstered with fabric or leather, Metal feet in dark grey epoxy paint finish

LALALAND 爱乐
L&L Studio



尺寸: 2500*2400*1020mm (床垫 2000*2000mm)
2300*2400*1020mm (床垫 1800*2000mm)
2000*2400*1020mm (床垫 1500*2000mm)
1850*2400*1020mm (床垫 1350*2000mm)
编号: 61F012

产品描述: 床为布料或牛皮包制, 床腿为黑丝光烤漆金属。含床箱

PRODUCT DESCRIPTION: Upholstered with fabric or leather. Metal feet in black satin finish. Bed includes hidden storage compartment

CITTI 西提
Frank Chou 周宸宸

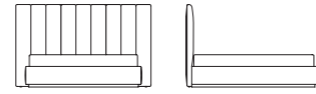

尺寸: 2500*2175*1300mm (床垫 2000*2000mm)
1500*2175*1300mm (床垫 1500*2000mm)
更多尺寸详见官网
编号: 61F007

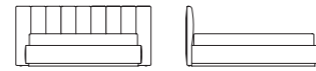

尺寸: 2500*2175*1040mm (床垫 2000*2000mm)
1500*2175*1040mm (床垫 1500*2000mm)
更多尺寸详见官网
编号: 61F001

产品描述: 床为布料或牛皮包制, 床底框为木制金色烤漆

PRODUCT DESCRIPTION: Upholstered with fabric or leather, wooden base frame in gold lacquer finish

LONJA 龙佳
Santiago Sevillano



带床尾板 WITH FOOTBOARD
尺寸: 2210*2270*1100mm (床垫 2000*2000mm)
2010*2270*1100mm (床垫 1800*2000mm)
1810*2270*1100mm (床垫 1600*2000mm)
1710*2270*1100mm (床垫 1500*2000mm)
编号: 61F003



无床尾板 WITHOUT FOOTBOARD
尺寸: 2210*2215*1100mm (床垫 2000*2000mm)
2010*2215*1100mm (床垫 1800*2000mm)
1810*2215*1100mm (床垫 1600*2000mm)
1710*2215*1100mm (床垫 1500*2000mm)
编号: 61F008

产品描述: 床为布料或牛皮包制, 底部为香槟金镀钛不锈钢

PRODUCT DESCRIPTION: Upholstered with fabric or leather. Stainless steel frame in champagne gold titanium plating

FUGUE 富笛
Frank Chou 周宸宸



尺寸: 2320*2260*1150mm (床垫 2000*2000mm)
2120*2260*1150mm (床垫 1800*2000mm)
1920*2260*1150mm (床垫 1600*2000mm)
1820*2260*1150mm (床垫 1500*2000mm)
编号: 61F006

产品描述: 床为布料或牛皮包制, 底部为黑丝光烤漆金属

PRODUCT DESCRIPTION: Upholstered with fabric or leather. Metal feet in black satin finish

HOOP 霍普
L&L Studio

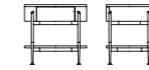

尺寸: 560*420*540mm
编号: 53C010

产品描述: 床头柜主体为木制开孔漆, 金属腿为黑灰氟碳漆

PRODUCT DESCRIPTION: Made in wood with metal legs in dark grey epoxy paint finish

ANNI 悠然
L&L Studio

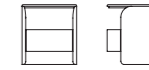

尺寸: D500*550mm
编号: 53C002

产品描述: 床头柜主体为木制开孔漆, 顶面与抽屉正面为烤漆

PRODUCT DESCRIPTION: Made in wood with top and drawer front in colored lacquer finish

LONJA 龙佳
Santiago Sevillano



尺寸: 516*466*540mm
编号: 53C004 / 53C005

产品描述: 床头柜主体为木制开孔漆, 抽屉正面为烤漆或木制开孔漆, 金属框为香槟金镀钛不锈钢

PRODUCT DESCRIPTION: Made in wood with drawer front in colored lacquer finish or wood. Stainless steel legs in champagne gold titanium plating

RITA 瑞达
L&L Studio

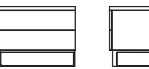

尺寸: 700*480*500mm
600*480*500mm
编号: 53C007

产品描述: 床头柜主体为木制开孔漆, 桌面为皮质, 底腿为黑灰氟碳漆金属

PRODUCT DESCRIPTION: Made in wood with leather top insert. Metal feet in dark grey epoxy paint finish

BELLA 贝拉
L&L Studio

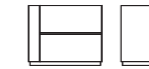

尺寸: 700*495*500mm
编号: 53C008

产品描述: 床头柜主体为木制开孔漆, 桌面为皮质。产品分左右

PRODUCT DESCRIPTION: Made in wood with leather top insert. Available in both left and right unit

LARGO 罗曼
L&L Studio

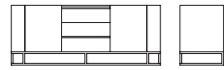

尺寸: 2138*490*670mm
1860*490*670mm
1660*490*670mm
编号: 52C007

产品描述: 主体为开孔漆, 金属底腿为黑镜镀钛不锈钢, 抽屉上方开房区内置烤漆装饰盒

PRODUCT DESCRIPTION: Made in wood with stainless steel legs in black titanium plating. Colored lacquer box inside the opening area

BELLA 贝拉
L&L Studio

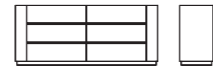

尺寸: 1906*450*800mm
1506*450*800mm
编号: 52C005

产品描述: 床头柜主体为木制开孔漆, 桌面为皮质

PRODUCT DESCRIPTION: Made in wood with leather top insert

BARRY 百瑞
Ximi Li 李希米

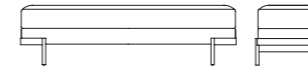

尺寸: 1810*485*450mm
1610*485*450mm
编号: 24F003

产品描述: 座椅整体为布料或牛皮包制, 椅腿为黑灰氟碳漆

PRODUCT DESCRIPTION: Upholstered with fabric or leather. Metal Legs in dark grey epoxy paint finish

CITTI 西提
L&L Studio



尺寸: 1750*420*450mm
1500*420*450mm
编号: 24F002

产品描述: 座椅整体为布料或牛皮包制, 底脚为黑丝光烤漆金属

PRODUCT DESCRIPTION: Upholstered with fabric or leather. Metal feet in black satin finish

LONJA 龙佳
Santiago Sevillano



尺寸: 1300*450*1270mm
编号: 14C002

产品描述: 主体为木制开孔漆, 金属框与镜框为香槟金镀钛不锈钢

PRODUCT DESCRIPTION: Made in wood with stainless steel legs and mirror frame in champagne gold titanium plating

LARGO 罗曼
P&P Studio



尺寸: 1200*450*1270mm
尺寸: 1000*450*1270mm
编号: 14C001

产品描述: 主体为木制开孔漆, 底腿为黑灰氟碳漆金属

PRODUCT DESCRIPTION: Made in wood with metal frame in dark dark grey epoxy paint finish

LONJA 龙佳
Santiago Sevillano

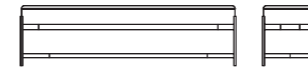

尺寸: 1816*416*450mm
1616*416*450mm
编号: 24F001

产品描述: 座椅整体为布料或牛皮包制, 椅腿为香槟金镀钛不锈钢

PRODUCT DESCRIPTION: Upholstered with fabric or leather. Stainless steel legs in Champagne gold titanium plating

PLUS 佳怡
Ximi Li 李希米



尺寸: 480*470*1270mm
编号: 53C006

产品描述: 主体为木制开孔漆, 衣架为镀钛不锈钢

PRODUCT DESCRIPTION: Made in wood with stainless steel shelf in titanium plating

LONJA 龙佳
Santiago Sevillano



尺寸: 1184*414*1820mm
编号: 56C001

产品描述: 整体框架和底层层板为香槟金镀钛不锈钢, 中间条几为木制开孔漆, 包含软包布料或皮质坐垫。左侧中花白大理石托盘, 下方另有木制开孔漆储物盒, 右侧挂镜香槟金镀钛不锈钢镶边

PRODUCT DESCRIPTION: Stainless steel frame and bottom panel in champagne gold titanium plating. Bench in wood with fabric or leather cushion. Left side includes a marble surface and wood storage, right side includes a mirror with frame in champagne gold titanium plating



书房

Home Office

DESK & BOOKCASE

书桌 & 书架



STRATA 斯巴达
Studio Roderick Vos



尺寸: 1760*400*1870mm
1760*400*1530mm
1560*400*1870mm
1560*400*1530mm
编号: 55C004

产品描述: 书柜整体烤漆

PRODUCT DESCRIPTION: Made in wood with colored lacquer finish

UO 优沃

Hi Thanks Bye



尺寸: 610*619*1788mm
编号: 71C008

产品描述: 置物架两侧板为岩绿色木制烤漆, 内置隔板为艳绿色金属烤漆

PRODUCT DESCRIPTION: Front and back wood panel and metal shelves and frame are all in green lacquer finish

RHYTHM 半岛

L&L Studio

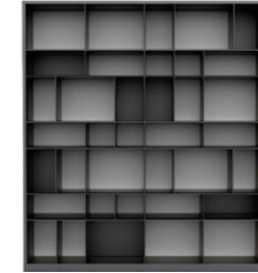

组合尺寸: 2374*357*2697mm
3526*357*2697mm
4390*357*2697mm

2374*357*2401mm
3526*357*2401mm
4390*357*2401mm

2374*357*1975mm
3526*357*1975mm
4390*357*1975mm
更多尺寸详见官网

编号: 55C002 / 55C003

产品描述: 书架主体为烤漆或木制开孔漆, 背板为白色哑光烤漆

PRODUCT DESCRIPTION: Cabinet frame and shelves in wood or lacquer finish. Back panel in white lacquer finish only

LARGO 罗曼

P&P Studio



尺寸: 1600*600*760mm
1400*600*760mm
1200*600*760mm
编号: 12C001

产品描述: 桌面与抽屉柜为木制开孔漆, 底架为黑镜镀钛不锈钢

PRODUCT DESCRIPTION: Table top and drawers in wood. Stainless steel frame in black titanium plating

GATHER 汇

Ximi Li 李希米



尺寸: 2380*980*750mm
2080*980*750mm
1800*900*750mm
编号: 12C002

产品描述: 书桌桌面及抽屉柜为木制开孔漆, 金属框架与腿为黑镜镀钛, 立腿为烤漆

PRODUCT DESCRIPTION: Desk top and drawers in wood. Metal frame in black titanium plating, side panel in colored lacquer finish

ACCESSORY 配饰

ILLUSION 叠影
MARIO TSAI 蔡列超



尺寸: 450*450*1500mm
编号: 72C001

产品描述: 整体香槟金镀钛不锈钢

PRODUCT DESCRIPTION: Whole piece in champagne titanium plating stainless steel

COSMO 星际
Masayuki Kurokawa 黑川雅之



尺寸: 40*40*40mm
编号: 71C007

产品描述: 整体黄铜拉丝或者透明亚克力

PRODUCT DESCRIPTION: Whole piece in brushed brass or clear acrylic

FLYING MIRROR 飞镜
MARIO TSAI 蔡列超



尺寸: 600*400*50mm
编号: 71C003

产品描述: 镜面和香槟金镀钛不锈钢

PRODUCT DESCRIPTION: Mirror with champagne titanium plating stainless steel

FLYING MIRROR 飞镜
MARIO TSAI 蔡列超



尺寸: 500*550*50mm
编号: 71C004

产品描述: 镜面和香槟金镀钛不锈钢

PRODUCT DESCRIPTION: Mirror with champagne titanium plating stainless steel

RUG 地毯

CORNICE 漫步
Studio Roderick Vos

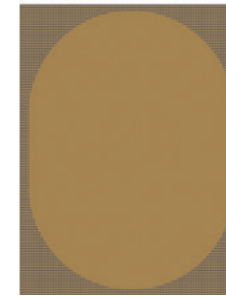

尺寸: 3442*4500mm
3060*4000mm
2612*3500mm
2326*3200mm
编号: 76C001-76C004

表面效果: 新西兰羊毛加丝

PRODUCT DESCRIPTION: New Zealand wool with silk

HALO 追光者
Studio Roderick Vos

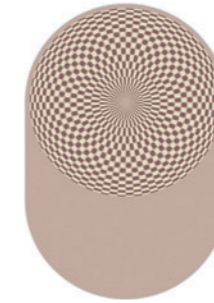

尺寸: 3000*4500mm
2667*4000mm
2334*3500mm
2134*3200mm
编号: 76C005-76C007

表面效果: 新西兰羊毛加丝

PRODUCT DESCRIPTION: New Zealand wool with silk

TUMBLE 探帛
Studio Roderick Vos



尺寸: 3015*4500mm
2670*4000mm
2345*3500mm
2144*3200mm
编号: 76C008, 76C009, 76C016

表面效果: 100% 新西兰羊毛

PRODUCT DESCRIPTION: 100% New Zealand wool

SPLICE 思莱
Studio Roderick Vos



尺寸: 1980*3060mm
2265*3500mm
2588*4000mm
2912*4500mm
2000*3500mm
2000*4000mm
2500*4000mm
2500*4500mm
编号: 76C010-76C015

表面效果: 50% 新西兰羊毛 + 50% 人棉丝

PRODUCT DESCRIPTION: 50% New Zealand wool + 50% Viscose

